

## Bio/CR Panel Through Wall Penetration - Pipe



Life Science Products, Inc.  
 124 Speer Road - Chestertown, MD 21620  
 www.lspinc.com

800-638-9874  
 (410) 778-6474  
 Fax (410) 778-4076

Size	Cage Code	Drawing Number	Rev
		GLWBCR62	4.17
Scale	Date	Sheet	

**THROUGH WALL  
OPENING COVER**

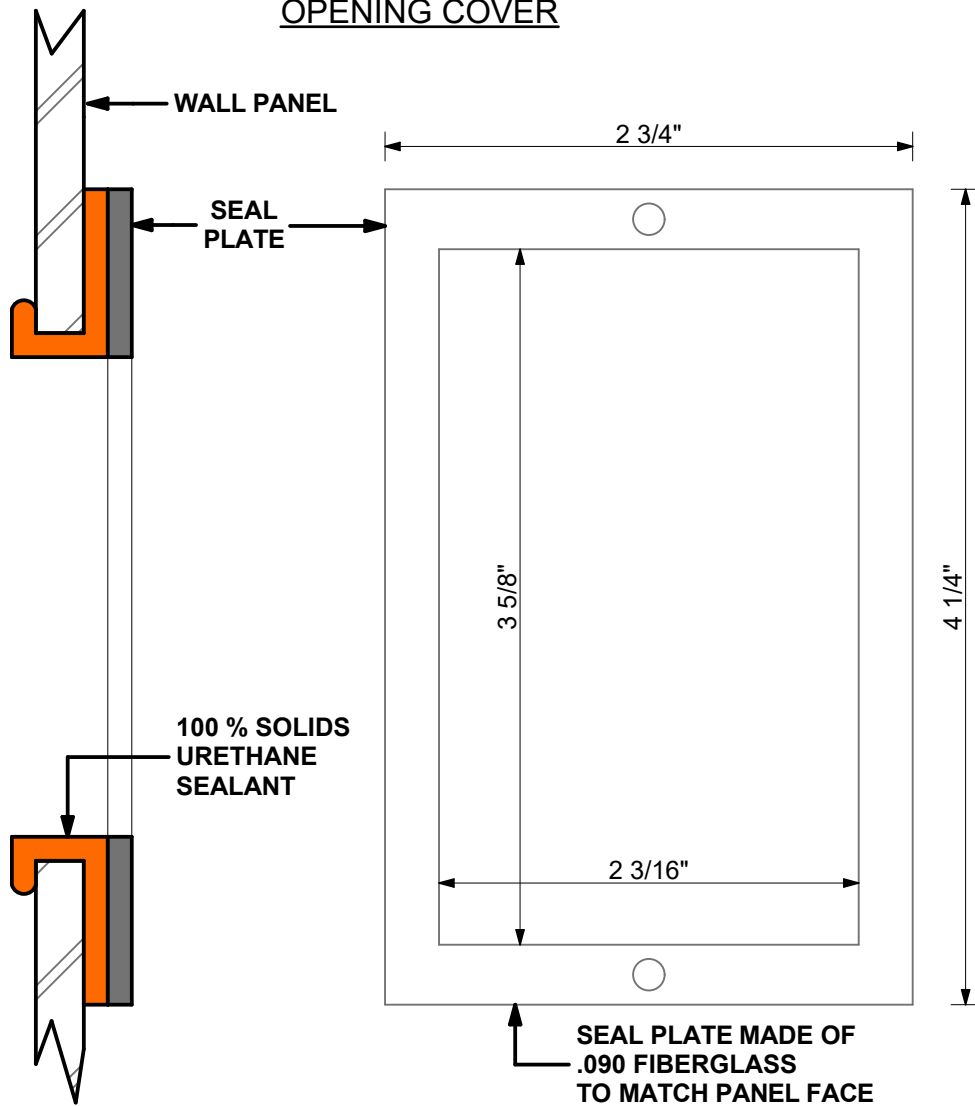

**SIDE VIEW**

**FRONT VIEW**

**THROUGH WALL  
DUPLEX BOX DETAIL**

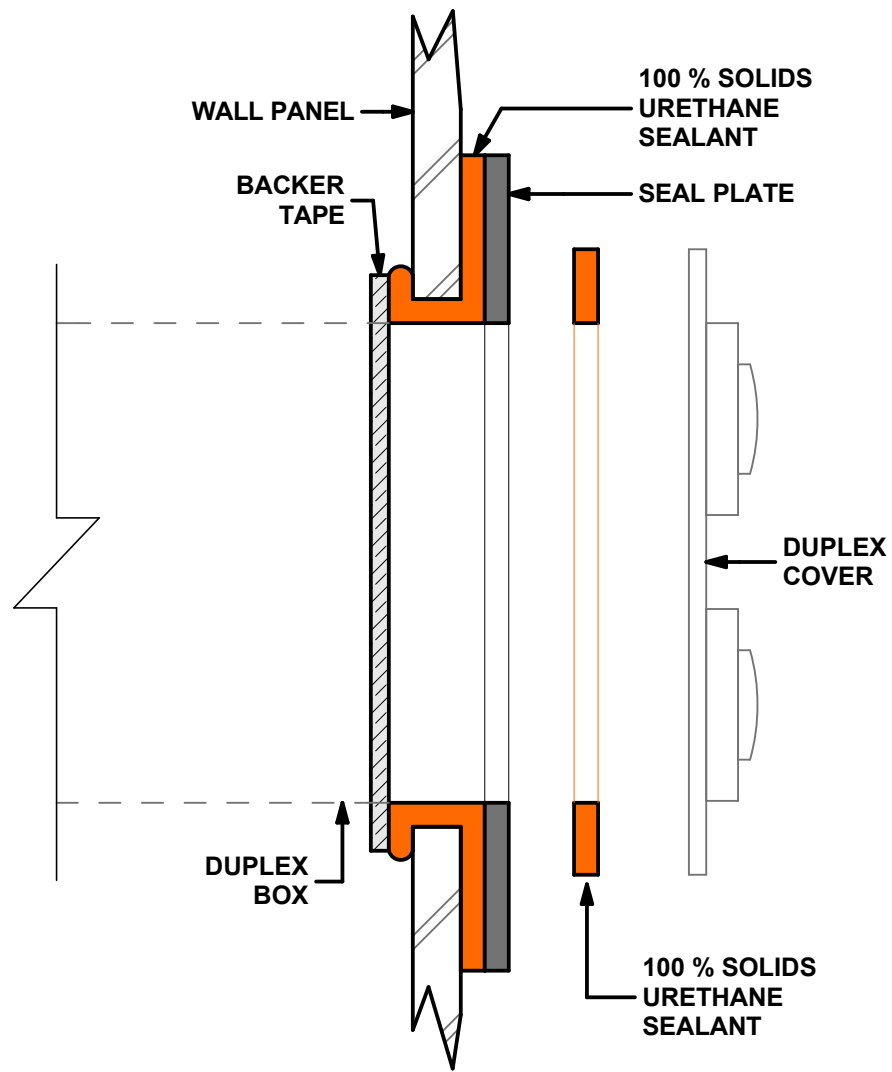

**SIDE VIEW**

**ELECTRICAL THROUGH WALL PENETRATION DETAIL**



Life Science Products, Inc.  
124 Speer Road - Chestertown, MD 21620  
www.lspinc.com

800-638-9874  
(410) 778-6474  
Fax (410) 778-4076

Size	Cage Code	Drawing Number	Rev
		E01	
Scale	Date	Sheet	
	7 FEB 16		

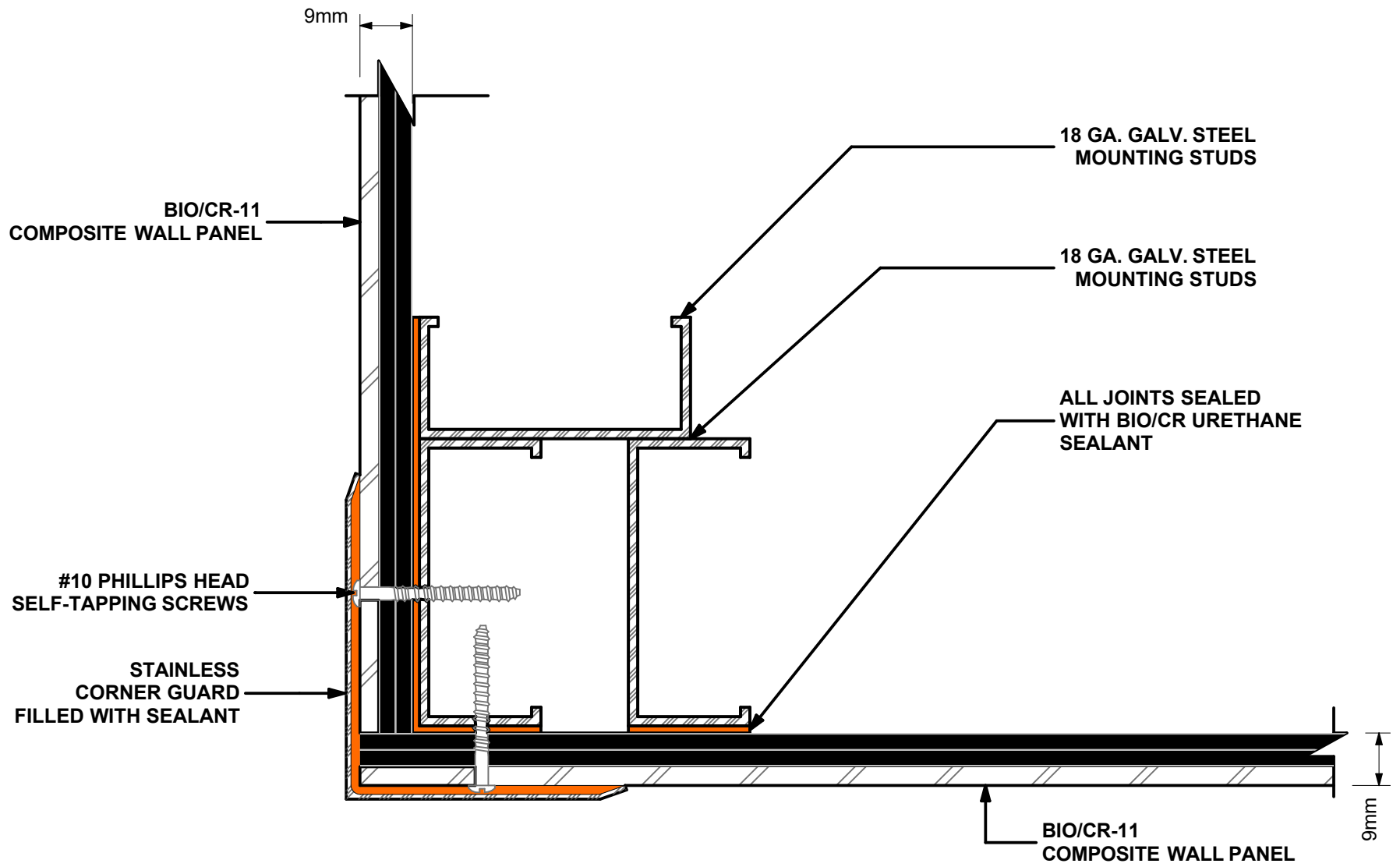

Bio/CR-11 Outside Corner Detail (Top View)



Life Science Products, Inc.  
 124 Speer Road - Chestertown, MD 21620  
 www.lspinc.com

800-638-9874  
 (410) 778-6474  
 Fax (410) 778-4076

Size	Cage Code	Drawing Number	Rev
		GLWBCR63	4.17
Scale	Date	Sheet	

**Finished View**

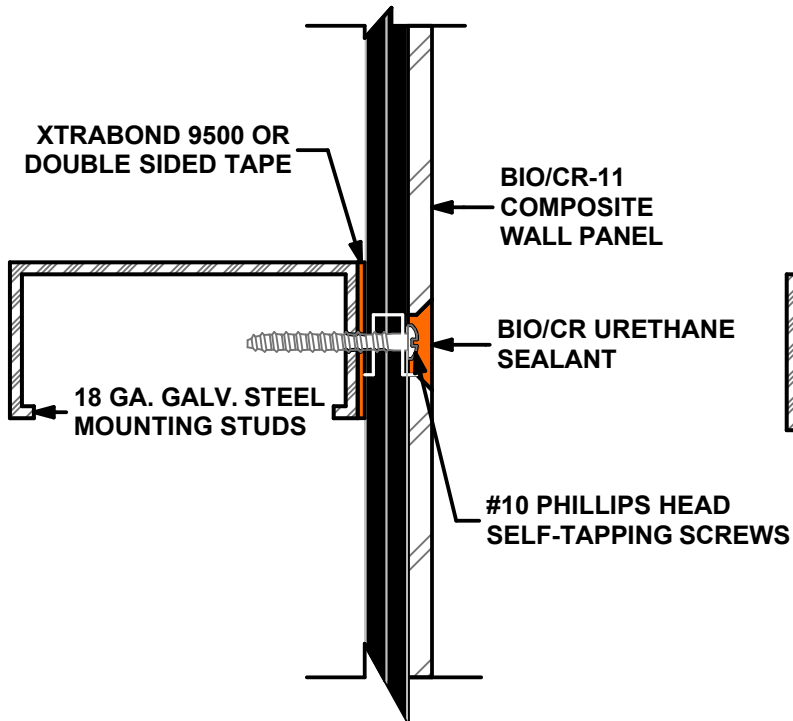

**Exploded View**

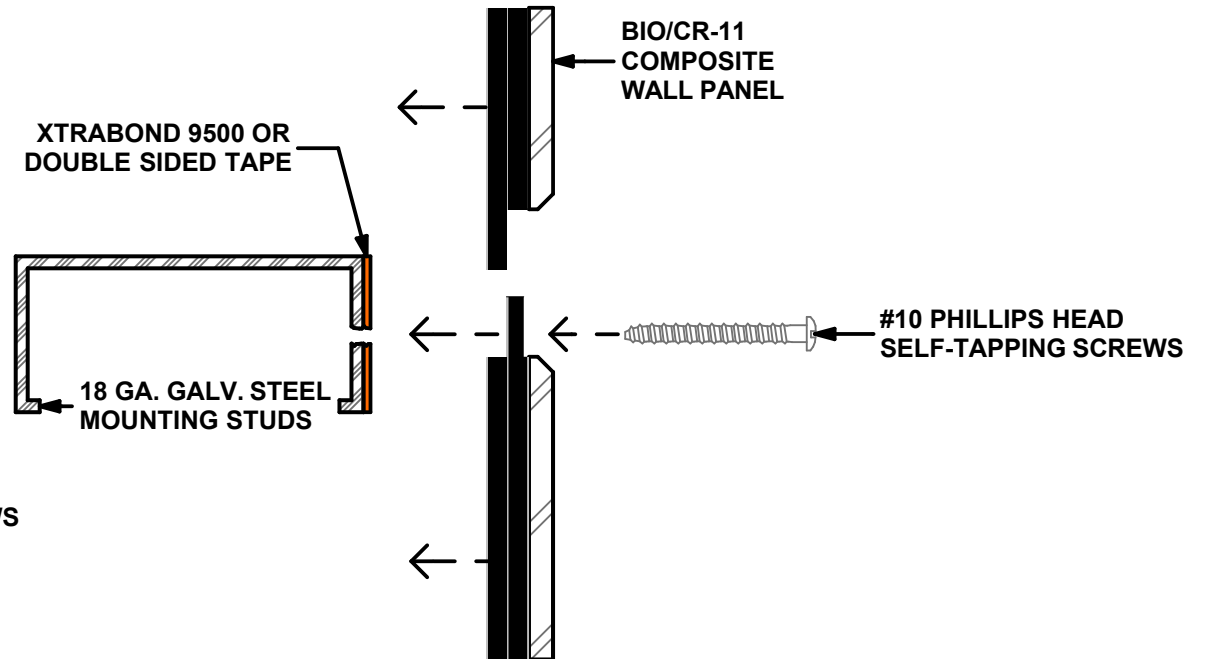

**Bio/CR-11 Clean Room Joint Detail**



Life Science Products, Inc.  
 124 Speer Road - Chestertown, MD 21620  
 www.lspinc.com

800-638-9874	Size	Cage Code	Drawing Number	Rev
(410) 778-6474			GLWBCR64	4.17
Fax (410) 778-4076	Scale	Date	Sheet	

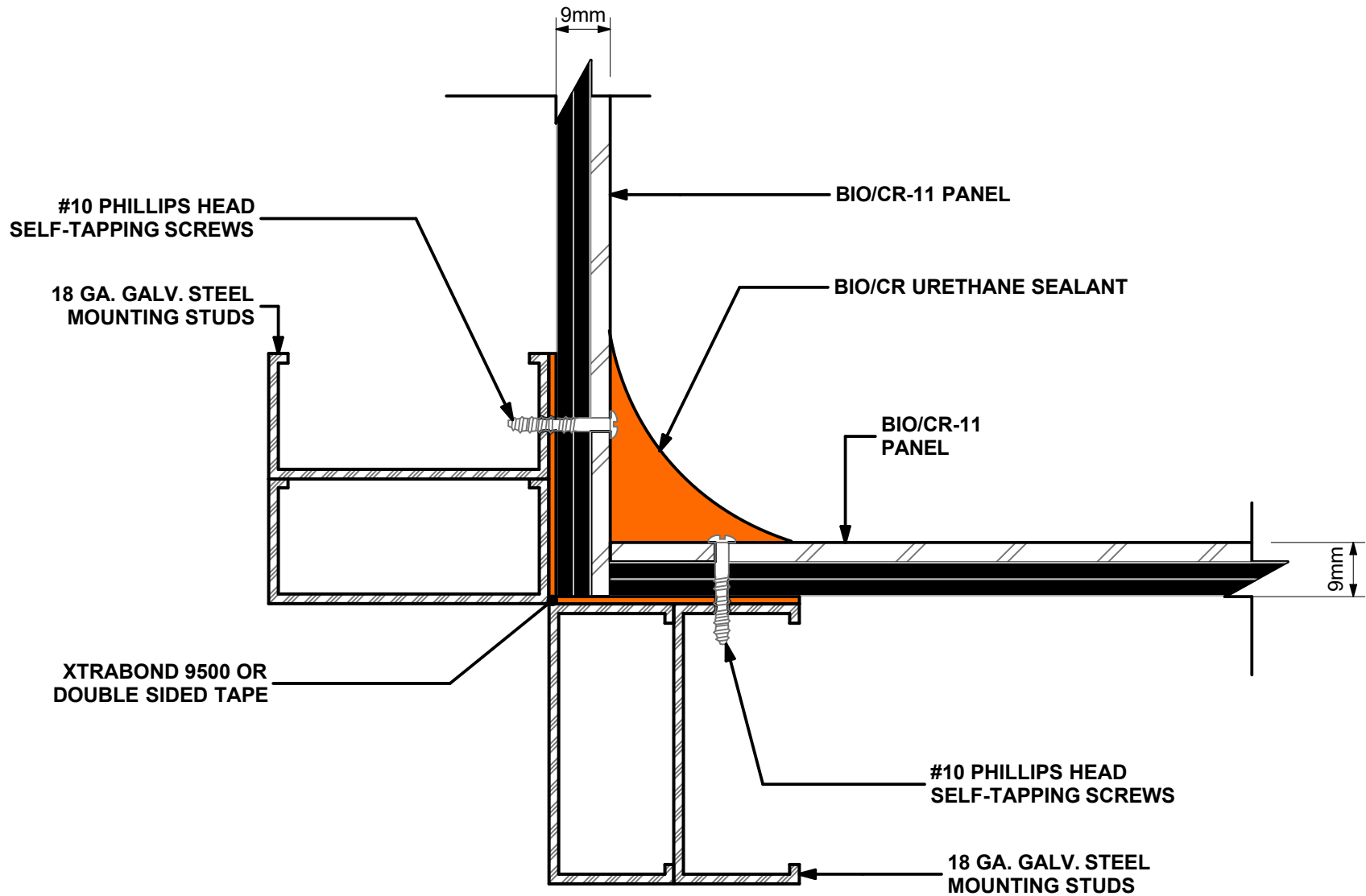

### Bio/CR-11 Inside Corner Detail



Life Science Products, Inc.  
 124 Speer Road - Chestertown, MD 21620  
 www.lspinc.com

800-638-9874  
 (410) 778-6474  
 Fax (410) 778-4076

Size	Cage Code	Drawing Number	Rev
		GLWBCR65	4.17
Scale	Date	Sheet	

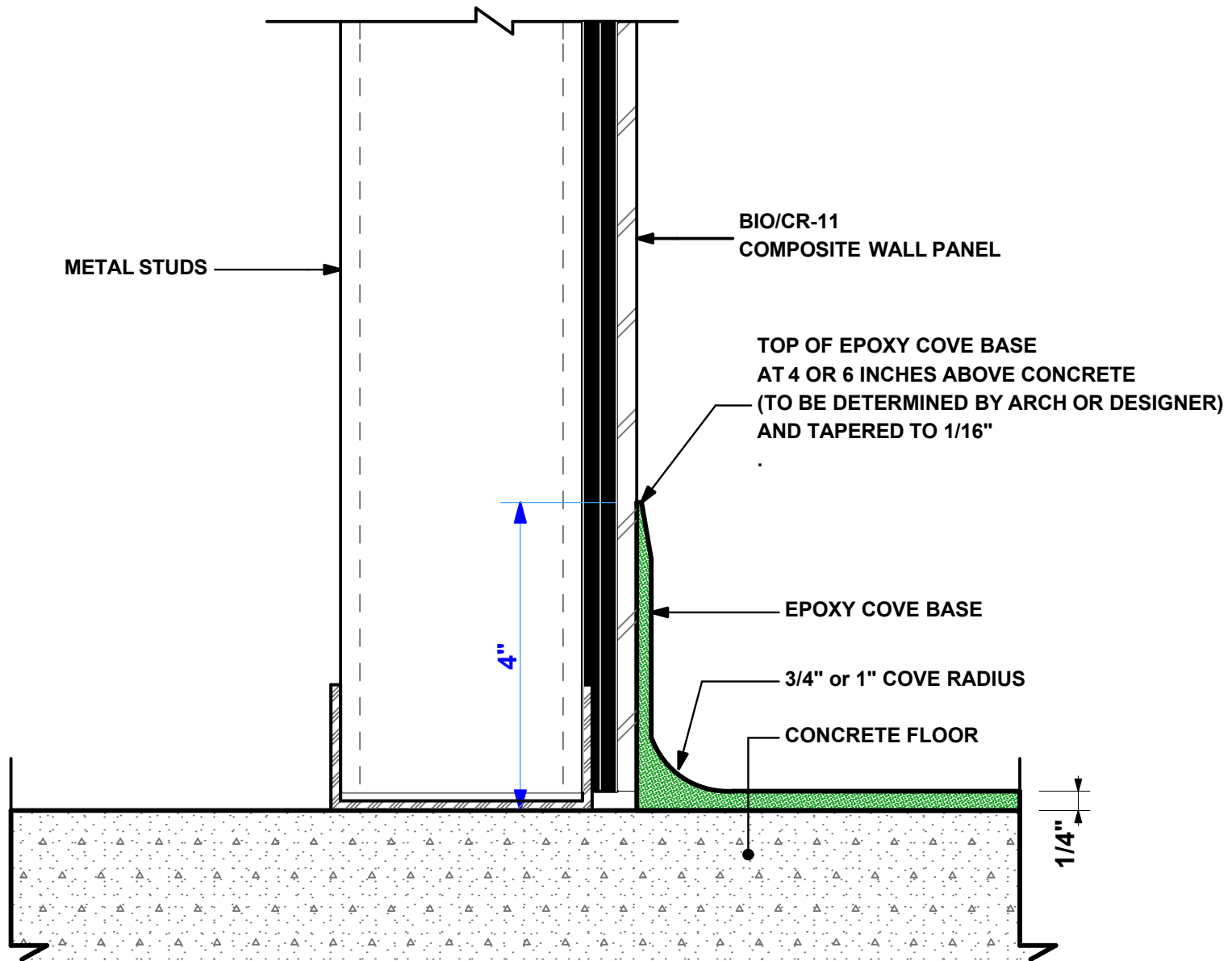

Bio/CR-11 Clean Room Cove Base Detail w/ Tapered Cove Base



Life Science Products, Inc.  
 124 Speer Road - Chestertown, MD 21620  
 www.lspinc.com

800-638-9874  
 (410) 778-6474  
 Fax (410) 778-4076

Size	Cage Code	Drawing Number	Rev
		GLWBCR-69	10.17
Scale	Date	Sheet	
NTS			

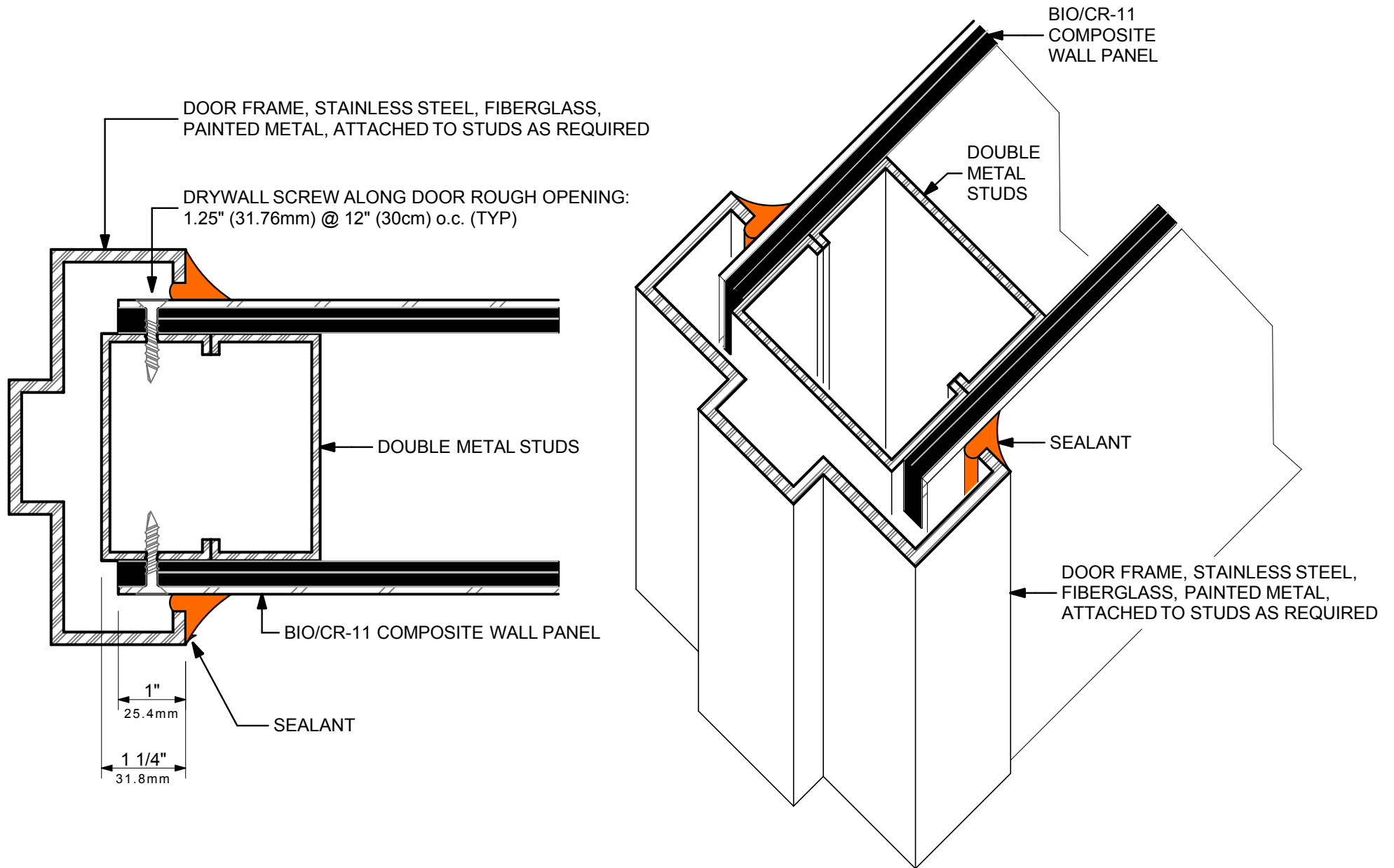

**Bio/CR-11 DOOR FRAME SEALING DETAIL, TYPICAL JAMB (HEAD SIMILAR)**



Life Science Products, Inc.  
 124 Speer Road - Chestertown, MD 21620  
 www.lspinc.com

800-638-9874  
 (410) 778-6474  
 Fax (410) 778-4076

Size	Cage Code	Drawing Number	Rev
		GLWBCR75	12.17
Scale	Date	Sheet	
6" = 1'-0"			

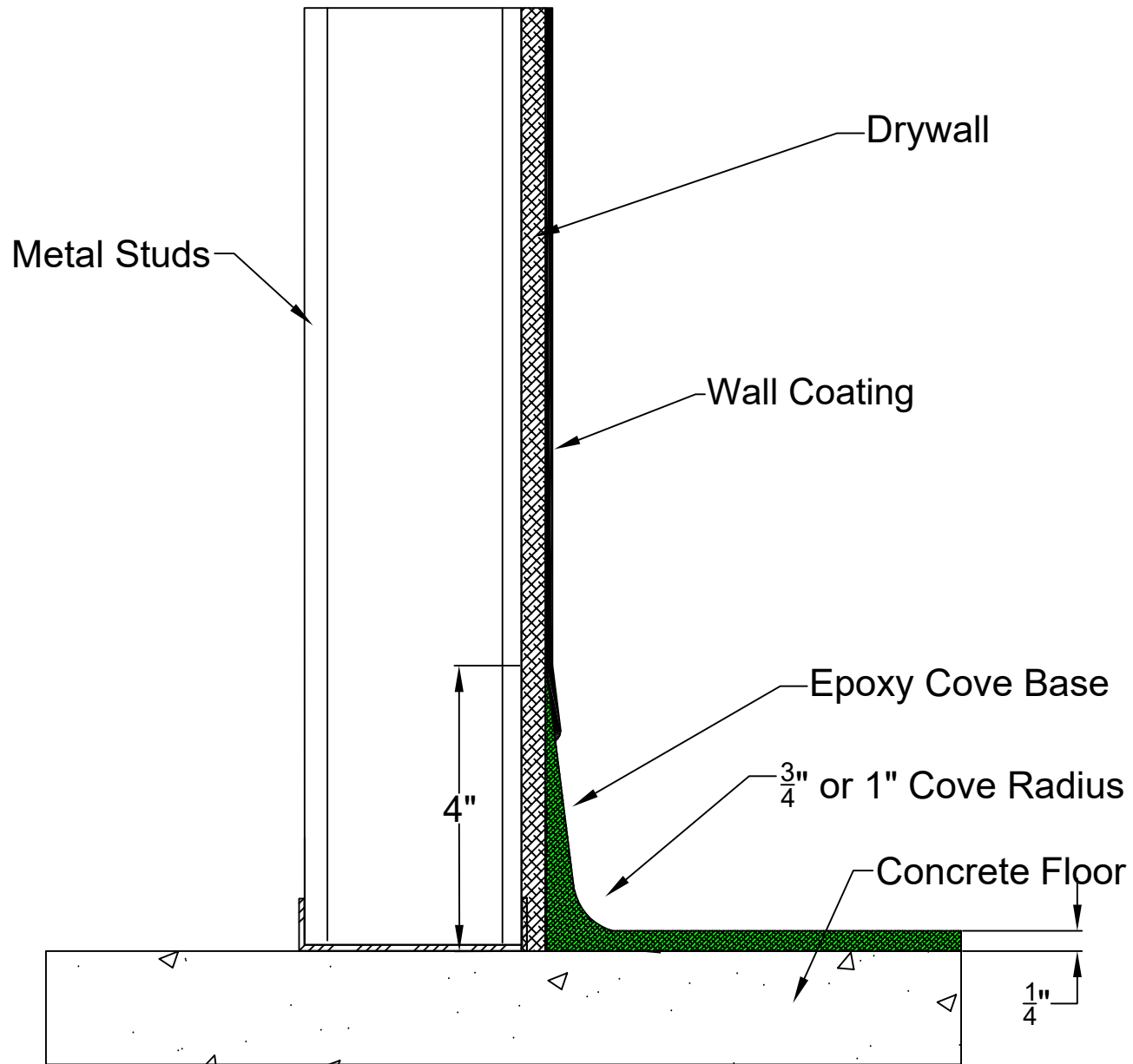

### Bio/CR-11 Clean Room Cove Base Detail



Life Science Products, Inc.  
 124 Speer Road - Chestertown, MD 21620  
[www.lspinc.com](http://www.lspinc.com)

800-638-9874  
 (410) 778-6474  
 Fax (410) 778-4076

Size	Cage Code	Drawing Number	Rev
		GLWBCR80	10.
Scale	Date		Sheet
NTS	6.19		



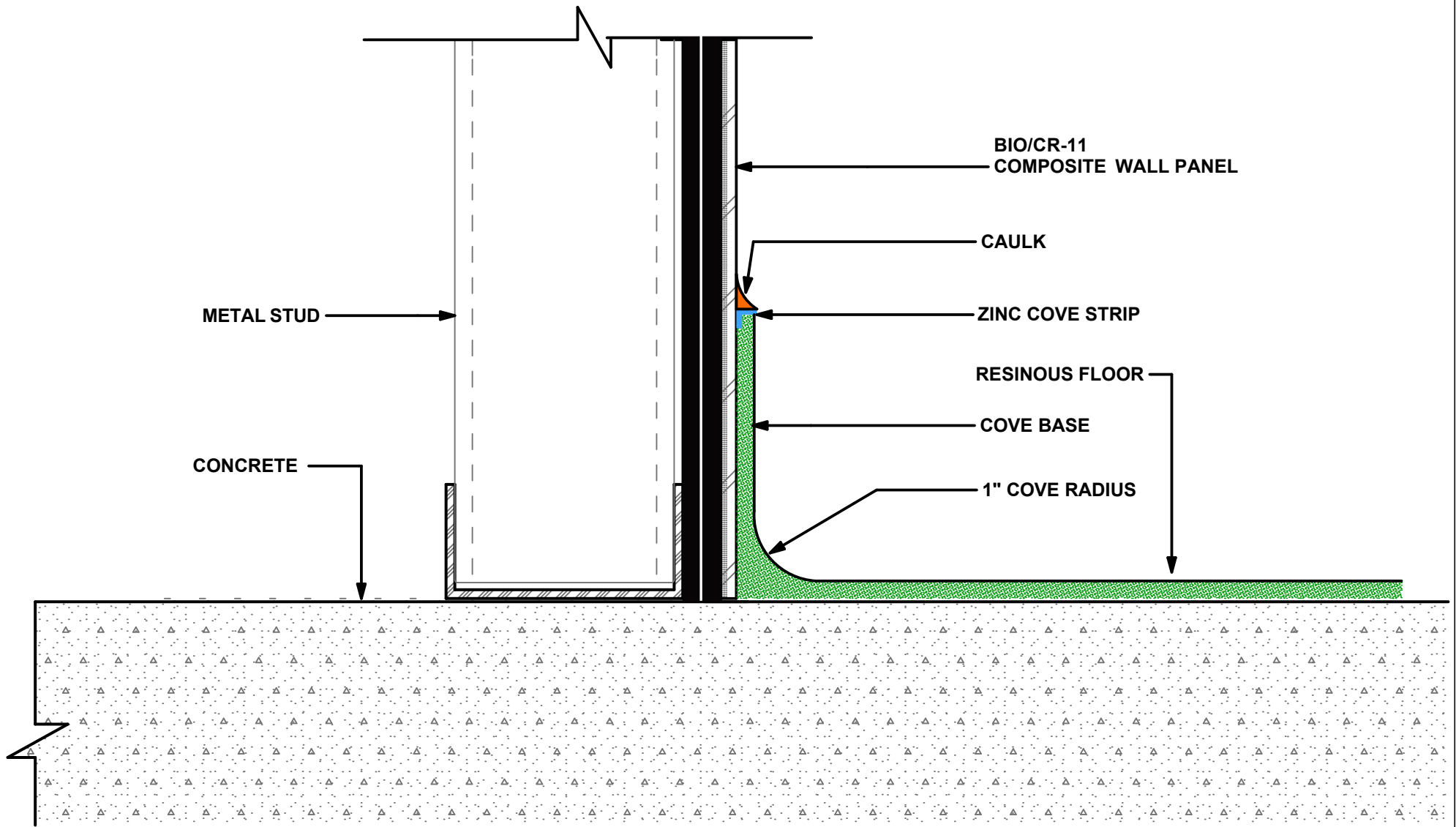

### Bio/CR-11 Standard Cove Base Details - End View



Life Science Products, Inc.  
 124 Speer Road - Chestertown, MD 21620  
 www.lspinc.com

800-638-9874  
 (410) 778-6474  
 Fax (410) 778-4076

Size	Cage Code	Drawing Number	Rev
		GLWBCR95	11.15
Scale	Sheet		

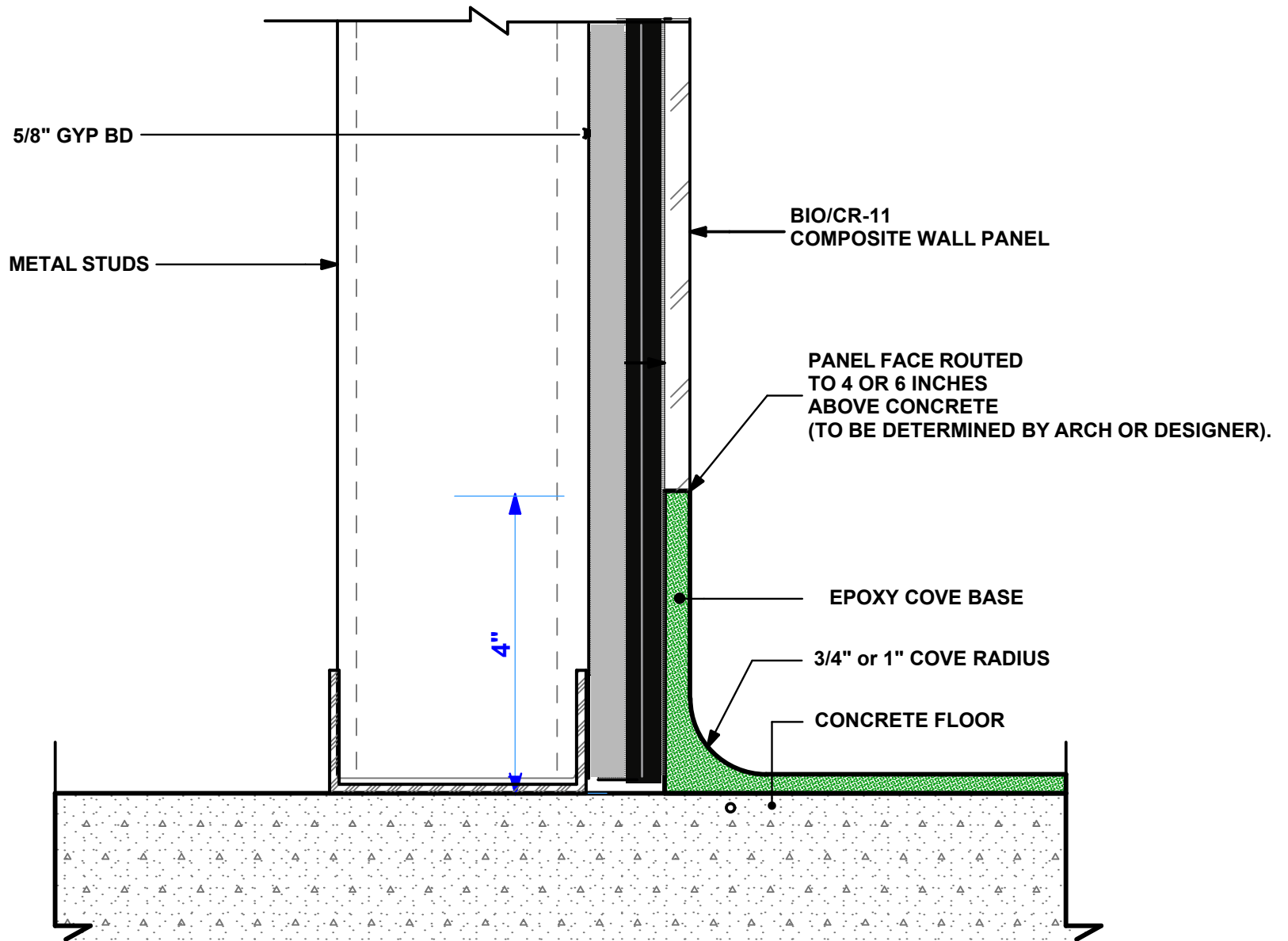

**Bio/CR- 11 Clean Room Cove Base Detail on Gyp**



Life Science Products, Inc.  
 124 Speer Road - Chestertown, MD 21620  
 www.lspinc.com

800-638-9874  
 (410) 778-6474  
 Fax (410) 778-4076

Size	Cage Code	Drawing Number	Rev
		GLWBCR 106	8.19
Scale			Sheet

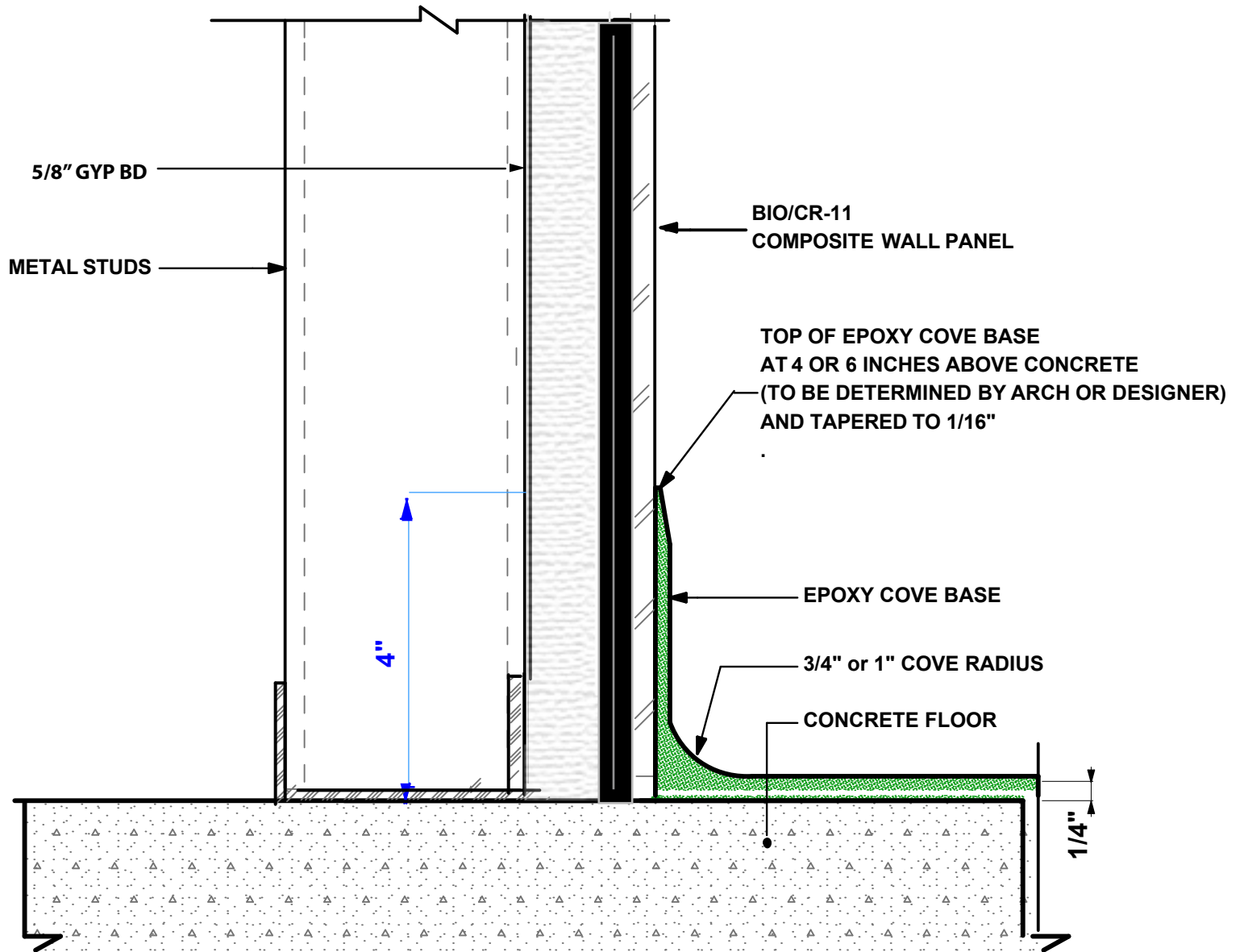

Bio/CR-11 (On Gyp) Clean Room Cove Base Detail w/ Tapered Cove Base



Life Science Products, Inc.  
 124 Speer Road - Chestertown, MD 21620  
 www.lspinc.com

800-638-9874  
 (410) 778-6474  
 Fax (410) 778-4076

Size	Cage Code	Drawing Number	Re 08.19
Scale NTS	Date	GLWBCR- 108	Sheet

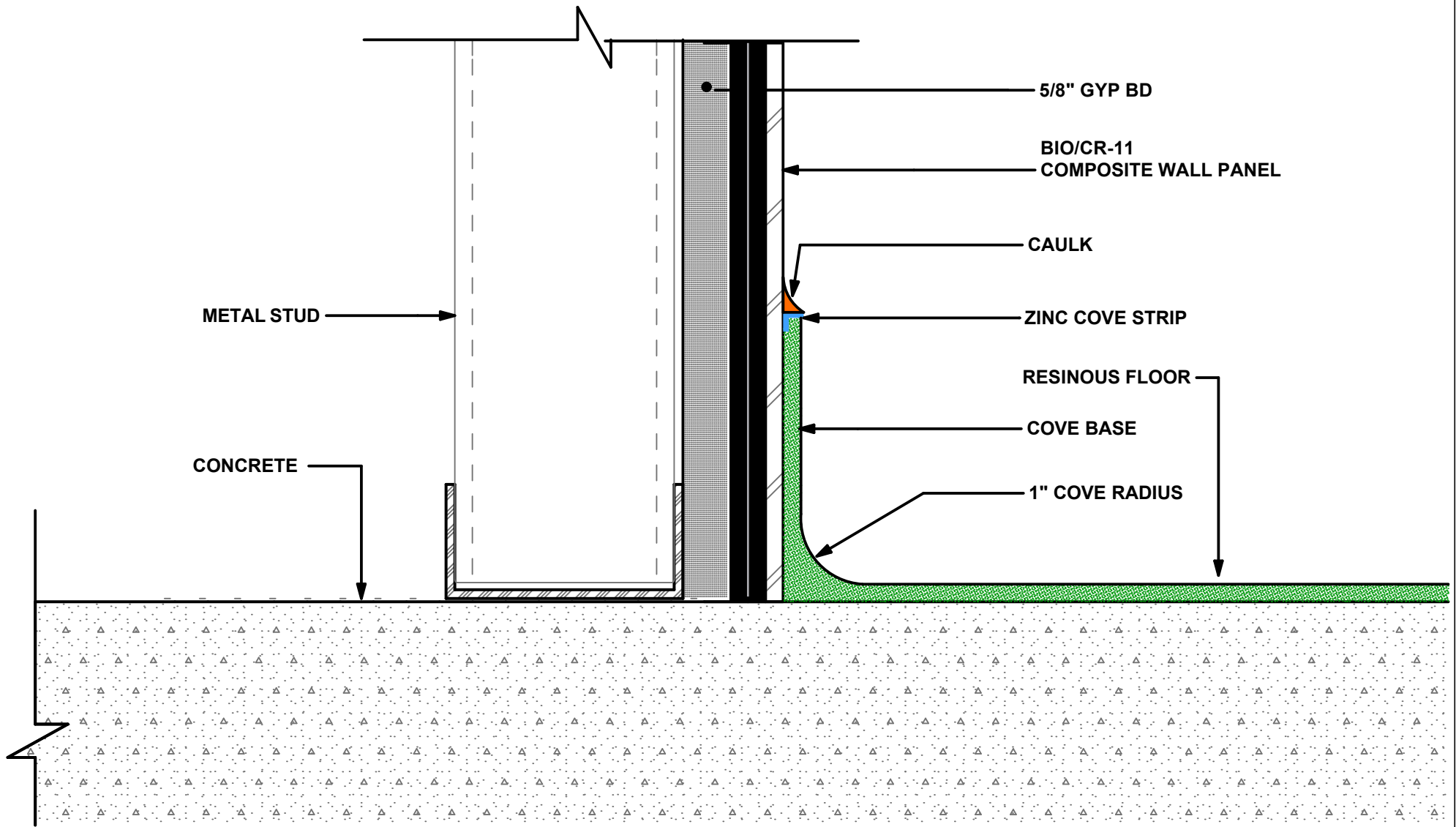

### Bio/CR-11 (On Gyp) Standard Cove Base Details - End View



Life Science Products, Inc.  
 124 Speer Road - Chestertown, MD 21620  
 www.lspinc.com

800-638-9874  
 (410) 778-6474  
 Fax (410) 778-4076

Size	Cage Code	Drawing Number	Rev
		GLWBCR110	8.19
Scale	Sheet		
6" = 1'-0"			